

Size: 4" , 5"

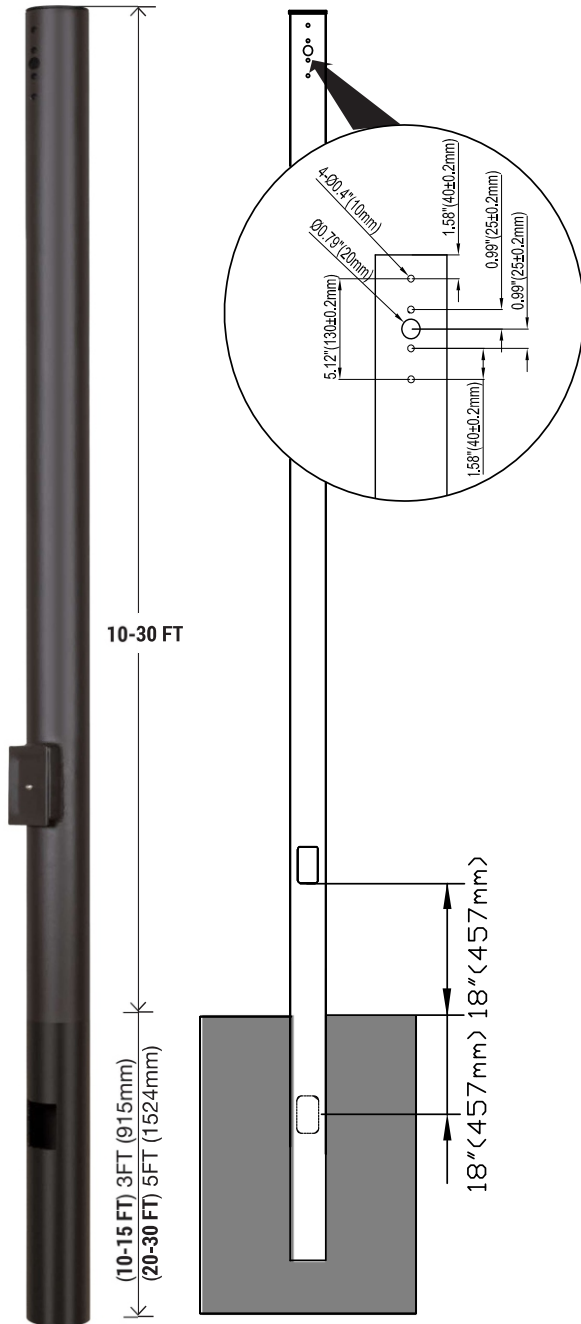

The WSD LED INC Series Direct Burial Straight Round poles are built from high strength steel tube and are available side drilled for arm mounted area lighting luminaires or with tenon mounts for flood and post top luminaires. Typical area lighting applications include retail centers, industrial parks, schools and universities, public transit and airports, office buildings and medical facilities. Mounting heights of 10 to 30 feet can be used based on selected luminaire application.

**(ACCESSORIES NEED TO PURCHASED SEPARATELY)**

### FEATURES

#### FINISH:

Textured architectural bronze powder-coat finish, baked to ensure maximum paint adhesion, hardness and durability.

#### ANCHOR BOLTS:

Anchor bolts are not included, sized based on pole data charts for the selected pole size.

#### POLE LENGTH:

Poles are available in standard lengths as shown in the order matrix. Poles can be custom cut to order. Consult factory.

#### SURFACE TREATMENT:

Hot-dip galvanizing.

**Note:** When using Arm Mounts, additional installation parts may be required to ensure proper installation. (example: with Slip-fitter a bullhorn will be the option) [see: additional installation parts for more options](#)

**TOP MOUNT:** Installing ARM (optional) will need to take-off the Tenon standard package and put rain cover on top.

**SPECIFICATIONS:** Conforms to ASTM-A 500 Grade B: Minimum Yield Strength of 46,000 PSI.

SPECIFICATION	10FT	15FT	20FT	25FT	30FT
WSD-RDB10FT4-11G-D					
WSD-RDB15FT4-11G-D					
WSD-RDB20FT4-11G-D	L = 3.0 (m) (GROUND HEIGHT)	L = 4.6 (m) (GROUND HEIGHT)	L = 6.1 (m) (GROUND HEIGHT)	L = 7.6 (m) (GROUND HEIGHT)	L = 9.1 (m) (GROUND HEIGHT)
WSD-RDB25FT4-11G-D					
WSD-RDB30FT5-11G-D					

### DIRECT UNDERGROUND BURIAL:



**BLACK ASPHALTUM:** Black Asphaltum is an economical, highly protective, acid and alkali-resistant coating designed for Direct burial Light Pole use.

This protective coating is applied on either galvanized or powder-coated products to add a supplemental layer of corrosion protection. This combination of galvanizing and/or powder coating coupled with black Asphaltum provides the best below-grade corrosion resistance in the Light Pole industry.

#### ADVANTAGE:

- Rust proofing properties
- Superior resistance to acids and alkali
- Outstanding adhesion and wear resistance

## DIRECT BURIAL STRAIGHT ROUND STEEL POLES - WSD Series

Size: 4" , 5"

### DIMENSION (Standard Fittings)

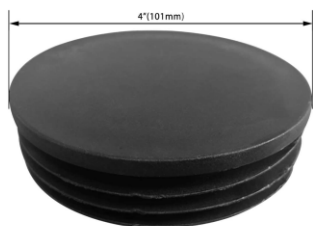

4 foot light pole to use



5 foot light pole to use

### DIMENSION DATA

CATALOG	GROUND HEIGHT	GAUGE	SIZE (Φ)	SUBSURFACE DEPTH	WEIGHT (LBS)	EPA 70	EPA 80	EPA 90	EPA 100	EPA 110	EPA 120	EPA 130	EPA 140
WSD-RDB10FT4-11G-D	10ft	11	4"	3 ft	74.8	28.2	23.5	20.3	19.4	17.3	15.6	12.3	9.8
WSD-RDB15FT4-11G-D	15ft				99	18.2	15.5	13.1	11.5	9.9	7.4	5.2	3.8
WSD-RDB20FT4-11G-D	20ft			132	12.2	10.3	8.8	7.2	6.1	4.6	2.2	1.0	
WSD-RDB25FT4-11G-D	25ft			154	11.9	8.9	7.7	6.1	5.6	4.2	1.1	0.5	
WSD-RDB30FT5-11G-D	30ft		5"	231	9.6	7.6	6.1	5.8	4.8	3.3	2.5	1.1	

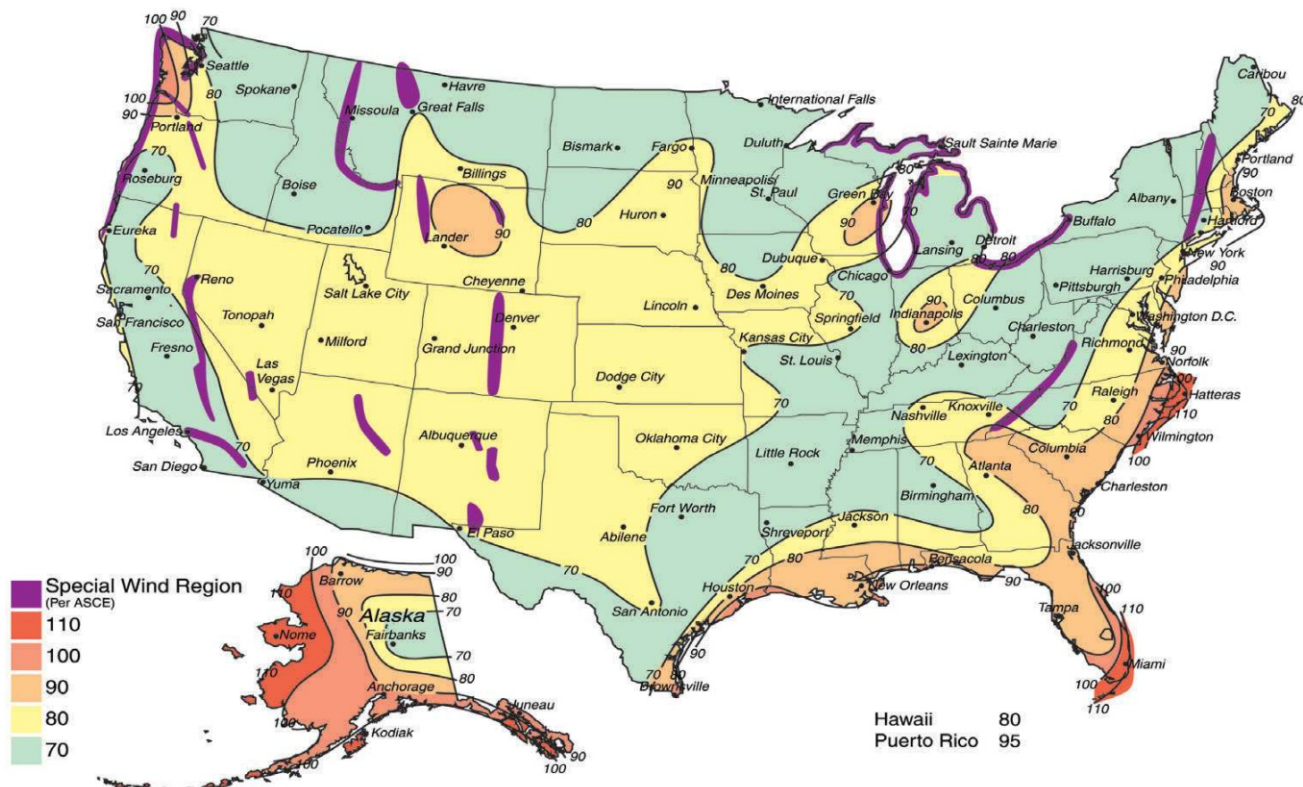

Size: 4" , 5"

### ORDERING INFORMATION

EXAMPLE: **WSD-RDB10FT4-11G-D**

WSD	RDB	10FT	4	11G	D
COMPANY	PRODUCT	GROUND HEIGHT	SIZE	THICKNESS	FINISH
WSD LED INC	Direct Burial Straight Round Steel poles	10FT - (3.0 M) 15FT - (4.6 M) 20FT - (6.1 M) 25FT - (7.6 M) 30FT - (9.1 M)	4 - (4" x 4") 5 - (5" x 5")	11G - (11 gauge)	D - (Dark Bronze)

### FIXTURE CONFIGURATIONS

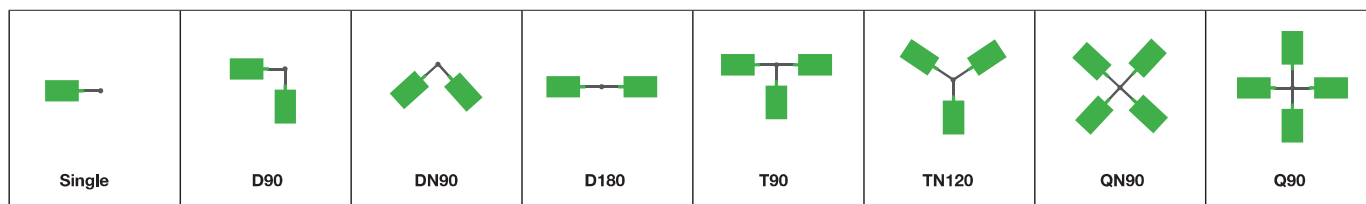

### INSTALLATION

#### Installation Guide

Step 1. After digging the corresponding size foundation hole by pressing the table at the location of the light pole installation, put the embedded end of the light pole into the hole, and keep it perpendicular to the ground, and fix it with concrete casting.

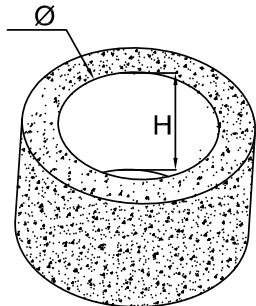
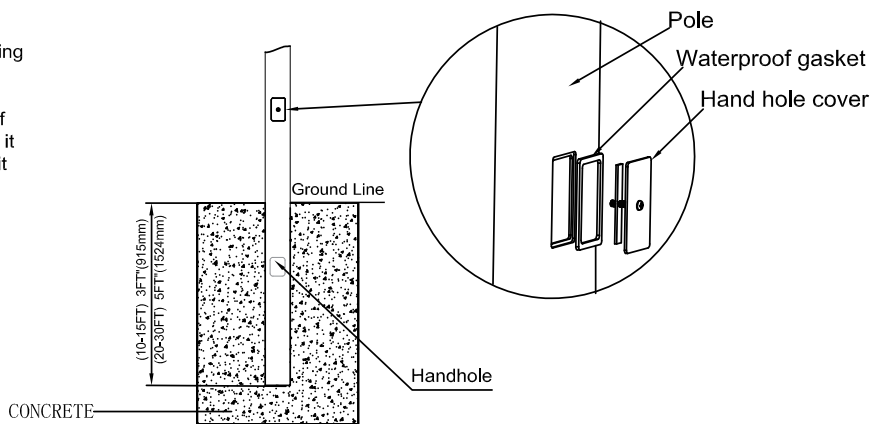

Reference design of Concrete size		
Specifications	Ø	H
10-15FT	31.5"(800mm)	59.1"(1500mm)
20-30FT	35.4"(900mm)	82.7"(2100mm)

**Foundation Design:** We offer Foundation design references due to variations in soil structure across different areas, and we do not assume any responsibility for this variability.





## DIRECT BURIAL STRAIGHT ROUND STEEL POLES - WSD Series

Size: 4", 5"

SQUARE EXTERNAL MOUNT HORIZONTAL TENON		• To mount 2/3/4 fixtures on an existing pole	
	<p><b>Low Profile Bullhorn with 3 Tenons</b>  <b>WSD-VTS4R-3T-D</b>            MAX EPA: 1.6            Finish: Dark Bronze            The Bracket is designed to mount over 2-3/8" O.D. vertical tenon.</p>		<p><b>Low Profile Bullhorn with 2 Tenons</b>  <b>WSD-VTS4R-2T-D</b>            MAX EPA: 1.0            Finish: Dark Bronze            The Bracket is designed to mount over 2-3/8" O.D. vertical tenon.</p>
	<p><b>Triple 120° Horizontal Tenon Adapter</b>  <b>WSD-QT120-3T-D</b>            MAX EPA: 1.4            Finish: Dark Bronze            The Bracket is designed to mount over 2-3/8" O.D. vertical tenon.</p>		<p><b>Quad 90° Horizontal Tenon Adapter</b>  <b>WSD-QT90-4T-D</b>            MAX EPA: 1.6            Finish: Dark Bronze            The Bracket is designed to mount over 2-3/8" O.D. vertical tenon.</p>
WALL BRACKET • Attaches to any flat surface • Provides wiring access		MID-POLE TENON BRACKET	
	<p><b>90° Wall Mount Bracket with 2-3/8" O.D. Tenon</b>  <b>WSD-ADP2.5-90-D</b>            MAX EPA: 0.6            Finish: Dark Bronze            The 90° wall mount bracket with 2-3/8" tenon attaches flood and area fixtures to almost any surface: wall, roof, or wood pole. Provides wiring access and a built-in 2-3/8" O.D. tenon to mount a fixture with our adjustable slip-fitter. Suggested 3/8" diameter bolts for mounting.</p>		<p><b>2-3/8" OD Horizontal Tenon Mid-Pole Bracket</b>  <b>WSD-ADP2.5-D</b>            MAX EPA: 0.3            Finish: Dark Bronze            2-3/8" OD Horizontal Tenon Mid-Pole Bracket is designed to mount light fixture that is equipped with a adjustable slip-fitter onto a 2-3/8" OD horizontal tenon.</p>
	<p><b>180° Wall Mount Bracket with 2-3/8" O.D. Tenon</b>  <b>WSD-ADP2.5-180L3.9-D</b>            MAX EPA: 0.5            Finish: Dark Bronze            The 180° wall mount bracket with 2-3/8" tenon attaches flood and area fixtures to almost any surface: wall, roof, or wood pole. Provides wiring access and a built-in 2-3/8" O.D. tenon to mount a fixture with our adjustable slip-fitter. Suggested 3/8" diameter bolts for mounting.</p>		<p><b>2-3/8" OD Horizontal Tenon Arc Adapter</b>  <b>WSD-ADP2.5-BAR5-D</b>            MAX EPA: 0.3            Finish: Dark Bronze            For use with Round, non-tapered steel and aluminum poles, 2-3/8" OD Horizontal Tenon Mid-Pole Bracket is designed to mount light fixture that is equipped with a adjustable slip-fitter onto a 2-3/8" OD horizontal tenon.</p>
POLE BRACKET • For mounting one fixture on an existing pole			
	<p><b>4" Square Pole Mount with 2-3/8" O.D. Tenon</b>  <b>WSD-VTS4-D</b>            MAX EPA: 0.3            Finish: Dark Bronze            For use with square, non-tapered steel and aluminum poles. Furnished with four 5/16" hex head stainless-steel bolts. Vertical tenon measures 2-3/8" O.D. and is made of steel tubing.</p>		<p><b>3" Round Pole Mount with 2-3/8" O.D. Tenon</b>  <b>WSD-VT3-D</b>            MAX EPA: 0.3            Finish: Dark Bronze            For use with round, non-tapered steel and aluminum poles. Furnished with four 3/8" hex head stainless-steel bolts. Vertical tenon measures 2-3/8" O.D.</p>
	<p><b>5" Square Pole Mount with 2-3/8" O.D. Tenon</b>  <b>WSD-VTS5-D</b>            MAX EPA: 0.3            Finish: Dark Bronze            For use with square, non-tapered steel and aluminum poles. Furnished with four 5/16" hex head stainless-steel bolts. Vertical tenon measures 2-3/8" O.D., and is made of steel tubing.</p>		<p><b>4" Round Pole Mount with 2-3/8" O.D. Tenon</b>  <b>WSD-VT4-D</b>            MAX EPA: 0.3            Finish: Dark Bronze            For use with round, non-tapered steel and aluminum poles. Furnished with four 3/8" hex head stainless-steel bolts. Vertical tenon measures 2-3/8" O.D.</p>
	<p><b>5" Round Pole Mount with 2-3/8" O.D. Tenon</b>  <b>WSD-VT5-D</b>            MAX EPA: 0.3            Finish: Dark Bronze            For use with round, non-tapered steel and aluminum poles. Furnished with four 3/8" hex head stainless-steel bolts. Vertical tenon measures 2-3/8" O.D., and is made of steel tubing.</p>		

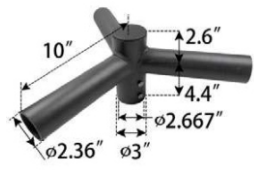
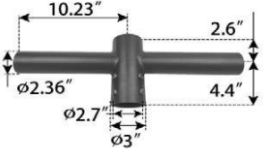
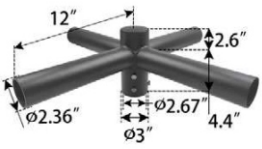

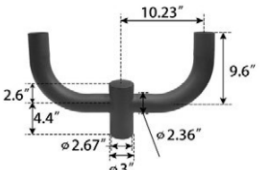
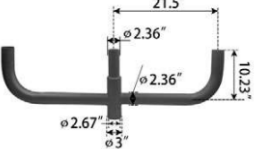
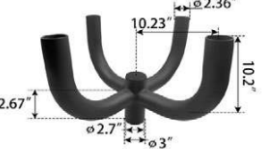
Size: 4" , 5"

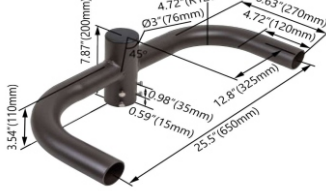
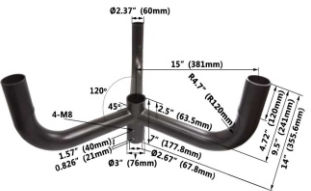
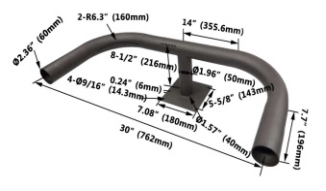
ROUND EXTERNAL MOUNT HORIZONTAL TENON · To mount 2/3/4 fixtures on an existing pole			
 <p><b>Double 90° Horizontal Tenon Adapter</b> <b>WSD-SB2.5TW90-D</b> MAX EPA: 0.6 Finish: Dark Bronze The Bracket is designed to mount over 2-3/8" (60mm) O.D. vertical tenon. Two fixtures can be mounted to the Round External Mount Horizontal Tenon and adjusted horizontally.</p>	 <p><b>Triple 120° Horizontal Tenon Adapter</b> <b>WSD-SB2.5TR120-D</b> MAX EPA: 0.7 Finish: Dark Bronze The Bracket is designed to mount over 2-3/8" (60mm) O.D. vertical tenon. Three fixtures can be mounted to the Round External Mount Horizontal Tenon and adjusted horizontally.</p>		
 <p><b>Double 180° Horizontal Tenon Adapter</b> <b>WSD-SB2.5TW180-D</b> MAX EPA: 0.4 Finish: Dark Bronze The Bracket is designed to mount over 2-3/8" (60mm) O.D. vertical tenon. Two fixtures can be mounted to the Round External Mount Horizontal Tenon and adjusted horizontally.</p>	 <p><b>Quad 90° Horizontal Tenon Adapter</b> <b>WSD-SB2.5QD90-D</b> MAX EPA: 0.3 Finish: Dark Bronze The Bracket is designed to mount over 2-3/8" (60mm) O.D. vertical tenon. Four fixtures can be mounted to the Round External Mount Horizontal Tenon and adjusted horizontally.</p>		
 <p><b>Single Spoke Bracket Tenon Adapter</b> <b>WSD-SB2.5S90-D</b> MAX EPA: 0.4 Finish: Dark Bronze The Bracket is designed to mount over 2-3/8" (60mm) O.D. vertical tenon. One fixture can be mounted to the Round External Mount Horizontal Tenon and adjusted horizontally.</p>	 <p><b>180° Double Bullhorn</b> <b>WSD-RB2.5D180-D</b> MAX EPA: 0.9 Finish: Dark Bronze The Bracket is designed to mount over 2-3/8" (60mm) O.D. vertical tenon. Two fixtures can be mounted to the Round External Mount Horizontal Tenon and adjusted horizontally.</p>		
 <p><b>180° Triple Bullhorn</b> <b>WSD-RB2.5TR180-D</b> MAX EPA: 1.4 Finish: Dark Bronze The Bracket is designed to mount over 2-3/8" (60mm) O.D. vertical tenon. Three fixtures can be mounted to the Round External Mount Horizontal Tenon and adjusted horizontally.</p>	 <p><b>90° Quad Bullhorn</b> <b>WSD-RB2.5QD90-D</b> MAX EPA: 1.5 Finish: Dark Bronze The Bracket is designed to mount over 2-3/8" (60mm) O.D. vertical tenon. Four fixtures can be mounted to the Round External Mount Horizontal Tenon and adjusted horizontally.</p>		
 <p><b>90° Wall Mount Bracket with 2-3/8" O.D. Tenon</b> <b>WSD-ADP2.5-90H-D</b> MAX EPA: 0.7 Finish: Dark Bronze The 90° wall mount bracket with 2-3/8" tenon attaches flood and area fixtures to almost any surface: wall, roof, or wood pole. Provides wiring access and abuilt-in 2-3/8" O.D. tenon to mount a fixture with our adjustable slip-fitter. Suggested 3/8" diameter bolts for mounting. Mounting holes are spaced 3-1/4" apart.</p>	 <p><b>Double 180° Horizontal Tenon Adapter</b> <b>WSD-RB2.5TR180H-D</b> MAX EPA: 1.0 Finish: Dark Bronze The Bracket is designed to mount over 2-3/8" (60mm) O.D. vertical tenon. Two fixtures can be mounted to the Round External Mount Horizontal Tenon and adjusted horizontally.</p>		
 <p><b>Triple 120° Horizontal Tenon Adapter</b> <b>WSD-SB2.5TR120V-D</b> MAX EPA: 1.5 Finish: Dark Bronze The Bracket is designed to mount over 2-3/8" (60mm) O.D. vertical tenon. Three fixtures can be mounted to the Round External Mount Horizontal Tenon and adjusted horizontally.</p>	 <p><b>Double 180° Wall Mount Bracket with 2-3/8" O.D. Tenon</b> <b>WSD-ADP2.5-180H-D</b> MAX EPA: 1.4 Finish: Dark Bronze The 180° wall mount bracket with 2-3/8" tenon attaches flood and area fixtures to almost any surface: wall, roof, or wood pole. Provides wiring access and abuilt-in 2-3/8" O.D. tenon to mount a fixture with our adjustable slip-fitter. Suggested 3/8" diameter bolts for mounting. Mounting holes are spaced 3-1/4" apart.</p>		

Size: 4" , 5"

	<p><b>Square Triple 90° Horizontal Tenon Adapter WSD-QT90-3T-D</b> MAX EPA: 1.5 Finish: Dark Bronze The Bracket is designed to mount over 2-3/8" O.D. vertical tenon.</p>		<p><b>Round Triple 90° Horizontal Tenon Adapter WSD-SB2.5QD90-3T-D</b> MAX EPA: 0.3 Finish: Dark Bronze The Bracket is designed to mount over 2-3/8" (60mm) O.D. vertical tenon. Triple fixtures can be mounted to the Round External Mount Horizontal Tenon and adjusted horizontally.</p>
	<p><b>Low Profile Bullhorn with 4 Tenons WSD-VTS4R-4T-D</b> MAX EPA: 1.7 Finish: Dark Bronze The Bracket is designed to mount over 2-3/8" O.D. vertical tenon.</p>		<p><b>Four 180° Horizontal Tenon Adapter WSD-RB2.5TR180-4T-D</b> MAX EPA: 1.4 Finish: Dark Bronze The Bracket is designed to mount over 2-3/8" (60mm) O.D. vertical tenon. Four fixtures can be mounted to the Round External Mount Horizontal Tenon and adjusted horizontally.</p>
<p><b>MOUNTING OPTIONS:</b></p>			
	<p><b>WSD-NEWSBARM2-D</b> Finish: Dark Bronze Arm Mount 4" and 5" Square and Round poles. Standard versatile mounting arm is simple to install and can be used with existing poles for retro installations.</p>		<p><b>WSD-NEWSBSF2-D</b> Finish: Dark Bronze Slipfitter Mount An optional cast aluminum mast arm adapter secures fixture head to nominal 2" (2-3/8" O.D. pipe size) horizontal steel tenon arm.</p>
	<p><b>WSD-SBT-D</b> Finish: Dark Bronze Easy to install for direct wall mounting with 1/2" conduit wiring.</p>		<p><b>WSD-SFARM2-D</b> Finish: Dark Bronze SFARM2 Mount An optional cast aluminum mast arm adapter secures fixture head to nominal 2" (2-3/8" O.D. pipe size) horizontal steel tenon arm.</p>
	<p><b>Arm Square Tube Turn Tube Tenon Adapter WSD-ARM-BAR-D</b> Finish: Dark Bronze Round tube light bar installation, with Arm installation of lamps.</p>		<p><b>Arm Square Tube Turn Tube Tenon Adapter WSD-SADP-BAR-D</b> Finish: Dark Bronze Round tube light bar installation, with Arm installation of lamps.</p>

**LIGHT POLE TOP**

