

TYPE: CR-7054

Emergency LED Mini Wall Pack Light accord with US STANDARD - Pressure casting-molded, flame-retardant and high impact thermoplastic housing. This exit sign with design is great for placing on doorways, isles, restaurant, office building and warehouses.



CR-7054



PRODUCT DISPLAY:

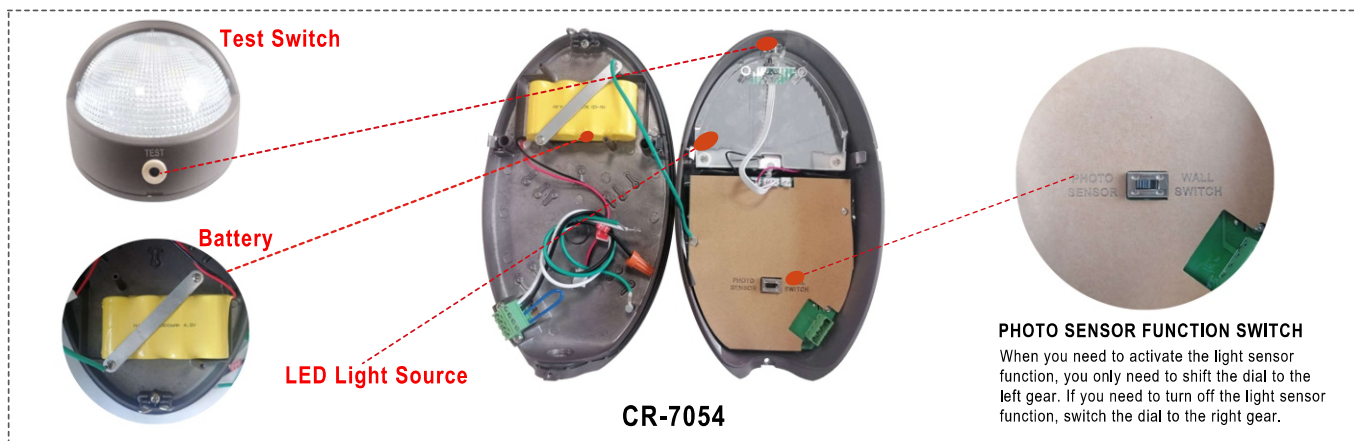

PHOTO SENSOR FUNCTION SWITCH
When you need to activate the light sensor function, you only need to shift the dial to the left gear. If you need to turn off the light sensor function, switch the dial to the right gear.

CR-7054

SPECIFICATION	
TYPE	CR-7054
WORKING VOLTAGE	120-277V 60Hz
POWER CONSUMPTION	4.8W max
OUTPUT	Super Bright COB LED 12W
BATTERY	4.8V 1800mAh Nickel Cadmium Battery
LUMEN	1000 LM
EMERGENCY LUMEN	400 LM
CONVERSION TIME	< 0.2 Second
EMERGENCY DURATION	90 Mins
RECHARGE TIME	24 Hours
PROTECTION LEVEL	IP65 Protection
OPERATION TEMPERATURE	0°C ~ 40°C
CERTIFICATION	UL
FINISH	Dark Bronze
CABLE	Input Connect, No cable
WARRANTY	2 year limited

TYPE: CR-7054

DIMENSION:

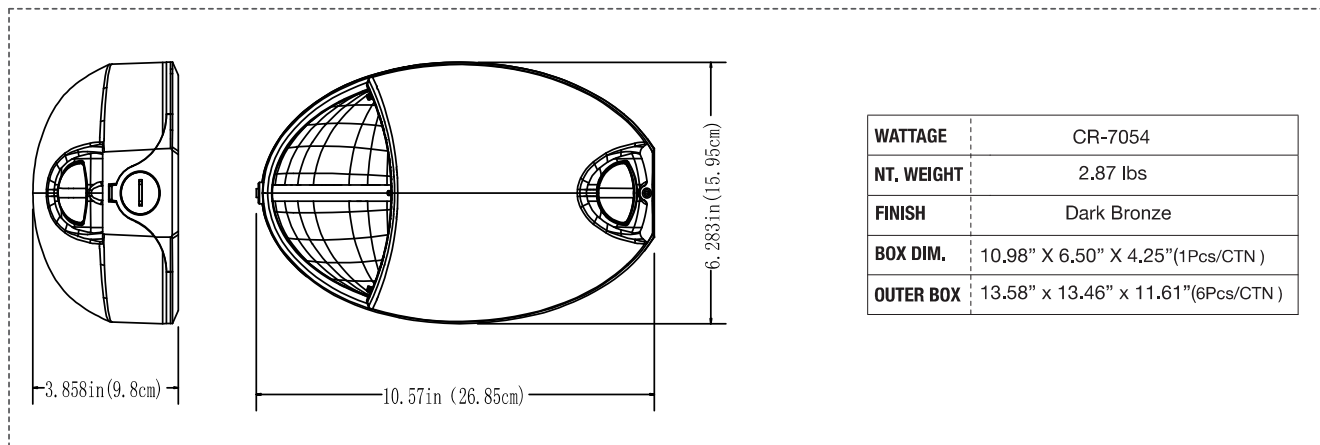

ORDERING INFORMATION

EXAMPLE:

CR-7054

CR	7054
CODE	CODE
WSD LED	7054 Product Code

MOUNTING ACCESSORIES: (Standard)



TYPE: CR-7054

WIRING DIAGRAM:

Fig. 1

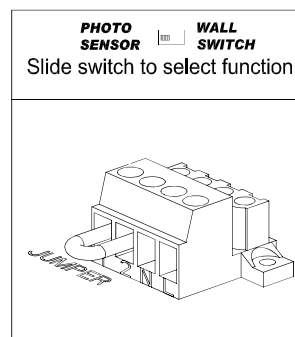
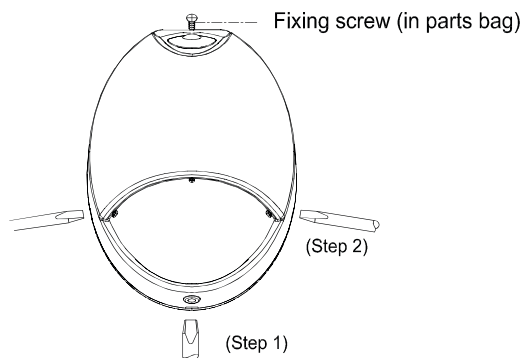

Fig. 2 Wall Mount - Back Power Feed

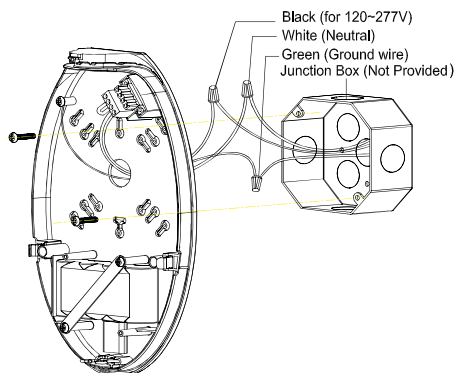

Fig. 3

Wall Mount -Surface Wiring (Top Power Feed Only)

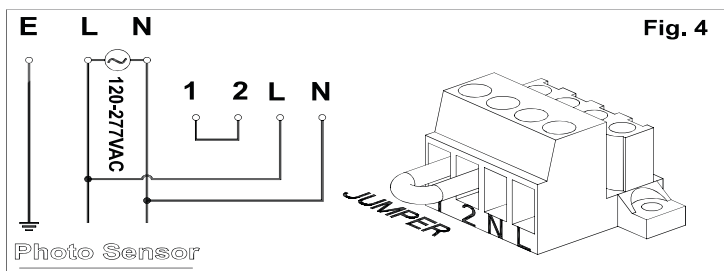
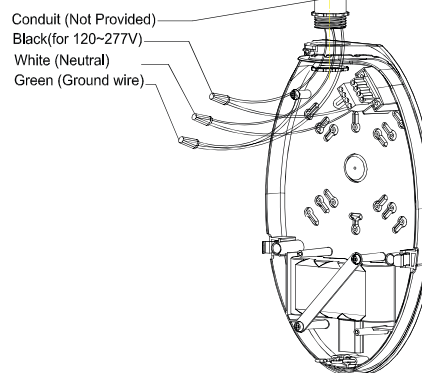

Fig. 4

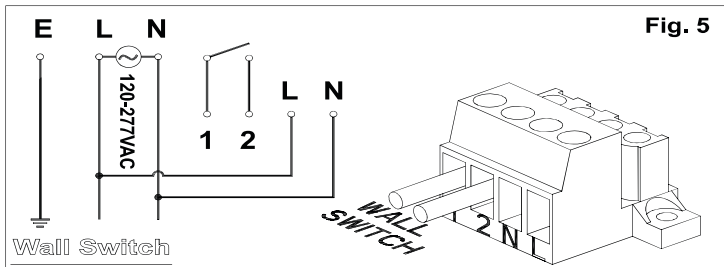
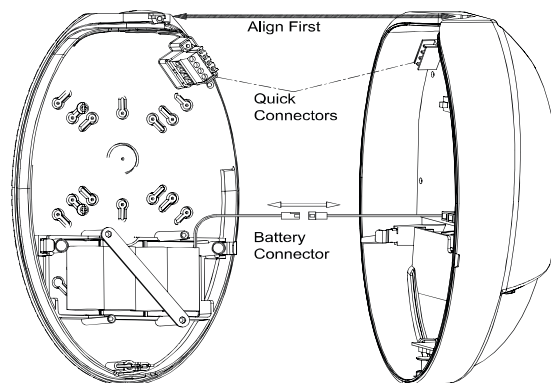

Fig. 5

Fig. 6



TYPE: CR-7054

INSTRUCTIONS :

NOTE: First turn off electricity.

Max Mounting Height: 11.1ft(3.3M)

1.Remove cover from fixture with a screwdriver.



2.Select working mode.

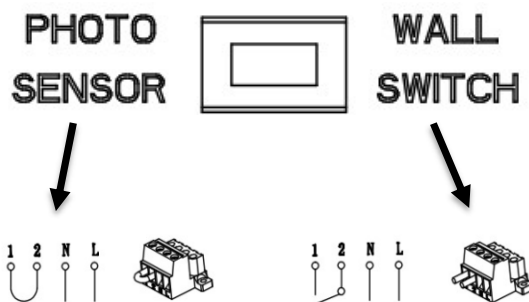

3.ELECTRICAL CONNECTIONS

Make the proper supply wire connections.
Connect L and N to building power supply.

4. Pull out all AC wires from the back of the fixture or top of the fixture for mounting. (J-box not provided)

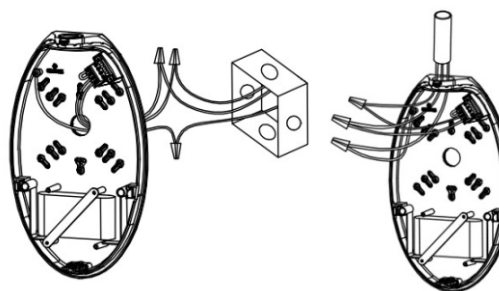

5. Restore power and press test button. AC light will turn off.

Function:

- When AC connected, the green indicator on.
- For normal lighting use, the fixture can be configured for automatic operation by the built-in daylight photo sensor, or can be switched through an external switch. For battery backup models the fixture will illuminate from battery power on loss of normal AC, regardless of the photo sensor or wall switch operation.
- For photo sensor operation, connect the jumper between terminals 1 and 2 (Pic2) and slide the slide switch (Pic4) to the Photo Sensor position. The photo sensor will turn the fixture on when the ambient lighting <10 Lux, and off when the ambient lighting >30 Lux.
- For an external switch: remove the jumper between terminals 1 and 2(Pic3), and slide the slide switch (Pic4) to the Wall Switch position. The external switch connections must be fully isolated from any other circuitry.

Photo Sensor Operation

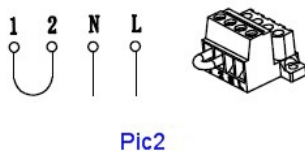

External Switch Operation

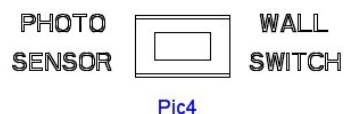
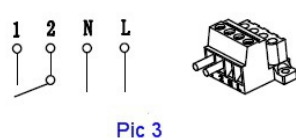

Pic4

Pic2

Pic 3