

LED SELECTABLE ARCHITECTURAL LINEAR LIGHT - WSD Series

Tunable Wattages:(2FT)15W/20W/25W ; (4FT)40W/45W/50W ; (8FT)65W/75W/90W



The Architecture Selectable LED Linear Light Series can be widely used for indoor (damp locations) Excellent for hospitals, schools, office, shops, restaurants, storage rooms, supermarkets, etc.

WATT/CCT
FIELD-ADJUSTABLE



TOP FEATURES

- 130 lm/W^[1], 1,950lm-11,700lm, DLC 5.1.
- Field-adjustable Power and CCT.
- Direct-Indirect flux ratio adjustable.
- Continuous run available.
- Multiple connection method.
- Motion Sensor Control Available (Option)

Dimensions

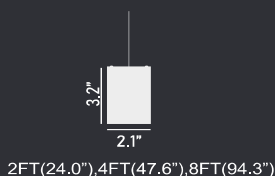

Distributions

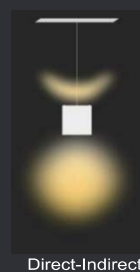

Direct-Indirect flux ratio adjustable

| Direct | Indirect |
|--------|----------|
| 100% | 0% |
| 70% | 30% |
| 50% | 50% |

| SPECIFICATION | | | |
|---------------------|----------------------------|----------------------------|----------------------------|
| TYPE | WSD-OL2FT152025W27-3545K-W | WSD-OL4FT404550W27-3545K-W | WSD-OL8FT657590W27-3545K-W |
| WATTAGE | (2FT) 15W/20W/25W | (4FT) 40W/45W/50W | (8FT) 65W/75W/90W |
| LUMEN | 1950 lm/2600lm/3250lm | 5200 lm/5850lm/6500lm | 8450 lm/9750 lm/11700 lm |
| EFFICACY | > 130 lm/W | | |
| CCT | 3500K/4000K/5000K | | |
| DEFAULT SETTING | 25W&4000K | 50W&4000K | 90W&4000K |
| CRI | 80 | | |
| INPUT VOLTAGE | AC120-277V | | |
| LIGHT ANGLE | 360° | | |
| POWER FACTOR | 0.90 | | |
| DRIVER EFFICACY | 86% | | |
| DIMMING | 1-10V Dimming | | |
| WORKING TEMPERATURE | -4°F ~ 122°F | | |
| LIFESPAN (L70) | 100,000 hours | | |
| PROTECTION LEVEL | Damp locations | | |
| CABLE | 5core,18AWG (59.06 inch) | | |
| WARRANTY | 5 year limited | | |

LED SELECTABLE ARCHITECTURAL LINEAR LIGHT - WSD Series

Tunable Wattages:(2FT)15W/20W/25W ; (4FT)40W/45W/50W ; (8FT)65W/75W/90W

DIMENSION

Unit:mm/inch

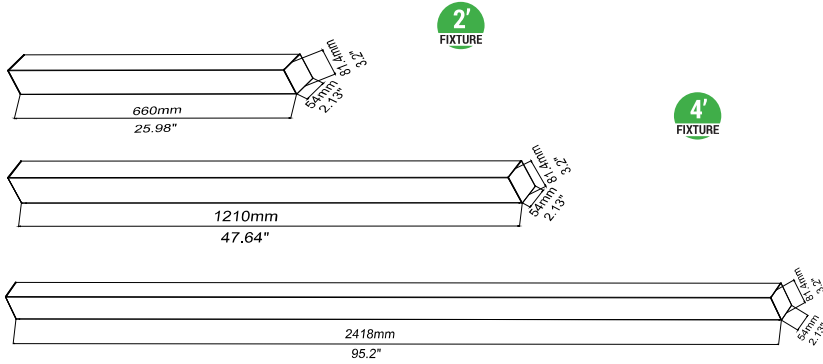

| | |
|------------|-------------------------|
| WATTAGE | 15W/20W/25W |
| GR. WEIGHT | 2.65 lbs (6 pcs/carton) |
| OUTER BOX | 30.04"X10.28"X7.87" |

| | |
|------------|-------------------------|
| WATTAGE | 40W/45W/50W |
| GR. WEIGHT | 4.41 lbs (6 pcs/carton) |
| OUTER BOX | 53.78"X9.84"X7.87" |

| | |
|------------|-------------------------|
| WATTAGE | 65W/75W/90W |
| GR. WEIGHT | 4.41 lbs (4 pcs/carton) |
| | 101.65"X10.08"X5.24" |

EMERGENCY BACK-UP (SOLD SEPARATELY)



(Available only for 4FT and 8FT models)

WSD-EMS8W27-XX
8W Emergency Backup Battery LED Driver

WSD-EMS15W27-XX
15W Emergency Backup Battery LED Driver

WSD-EMS20W27-XX
20W Emergency Backup Battery LED Driver

CONTROL (SOLD SEPARATELY)

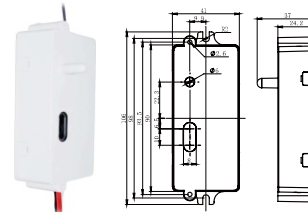

BR1810-B-D
Microwave Motion Sensor



RC-100
Microwave Sensor Remote Controller

STANDARD ACCESSORIES(standard)

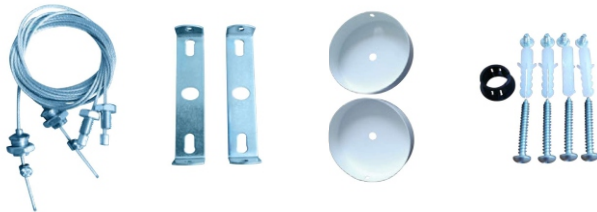

WSD-OL-CABLE
39.37 inch CABLE
(2FT,4FT,8FT)

WSD-OL-CROSS-BAR
CROSS-BAR
(2FT,4FT,8FT)

WSD-OL-CANOPY
CANOPY
(2FT,4FT,8FT)

WSD-OL-SRP
SCREW+RUBBER PLUG
(2FT,4FT,8FT)

STANDARD ACCESSORIES(SOLD SEPARATELY)

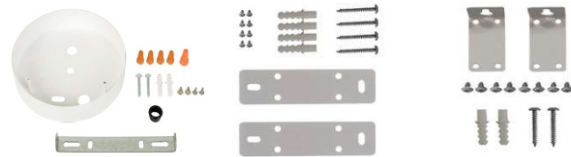

WSD-OL-CANOPY-M
CANOPY
Suitable for installation with Motion Sensor
(2FT,4FT,8FT)

WSD-OL-SMK
SURFACE MOUNTING KIT
(2FT,4FT,8FT)

WSD-OL-WMK
WALL MOUNTING KIT
(2FT,4FT,8FT)





ORDERING INFORMATION

EXAMPLE: **WSD-OL2FT152025W27-3545K-Z[D,W,B,S]-E[Blank,EC,M,ECM]**

| WSD | OL | 2FT | 152025 | 27 | 3545K | Z | E |
|-------------------|-----------------------|--------------|-----------------------------------|-----------------|--|---------------------------|---|
| PRODUCT | PRODUCT | SIZE | WATTAGE | VOLTAGE | CCT | FINISH | CONTROL |
| WSD (WSD LED INC) | OL (LED Linear Light) | 2FT (2-foot) | 152025W - (15W/20W/25W) | 27 - (120-277V) | 3545K - (3500K/4000K /5000K) | D (Dark Bronze) | M (Motion Sensor) |
| | | 4FT (4-foot) | 404550W - (40W/45W/50W) | | | W (White) | EC (Emergency) |
| | | 8FT (8-foot) | 657590W - (65W/75W/90W) | | | B (Black) | ECM (Emergency+Motion Sensor) |
| | | | | | | S (Silvery) | |

Tunable Wattages:(2FT)15W/20W/25W ; (4FT)40W/45W/50W ; (8FT)65W/75W/90W

MULTIPLE CONNECTION METHOD (SOLD SEPARATELY)

| | |
|--|--|
|  <p>WSD-OL180-2T "I" connector</p> |  <p>WSD-OL90-2T "L" connector</p> |
|  <p>WSD-OL90-3T "T" connector</p> |  <p>WSD-OL90-4T "+" connector</p> |

CONNECTING AND WIRING:

Power cord with rubber cable sheath, fixed to the pre-punched hole on one side of the fixture body

Both ends of the fixture has 2 connectors for wiring connection.

Female 3 pin JST SM Connector to light up the joiners.

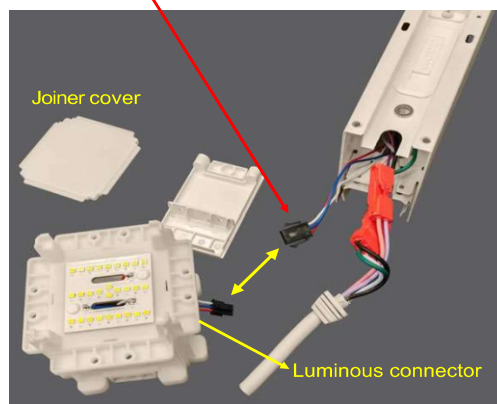
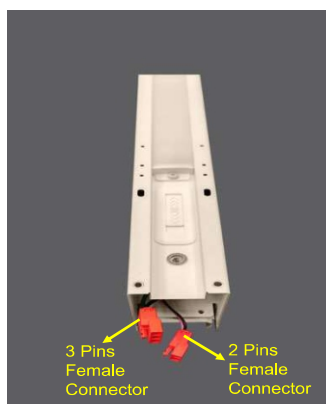
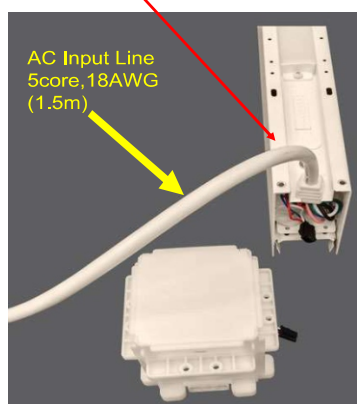

CONTROL MODULE:

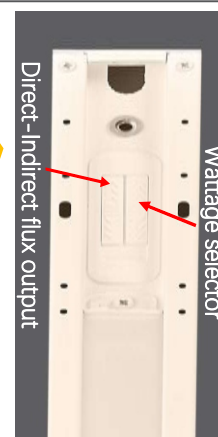

Tunable Wattages:(2FT)15W/20W/25W ; (4FT)40W/45W/50W ; (8FT)65W/75W/90W

PHOTOMETRICS

For complete IES files, please visit our website.

WSD-OL2FT152025W27-3545K (25W&4000K)

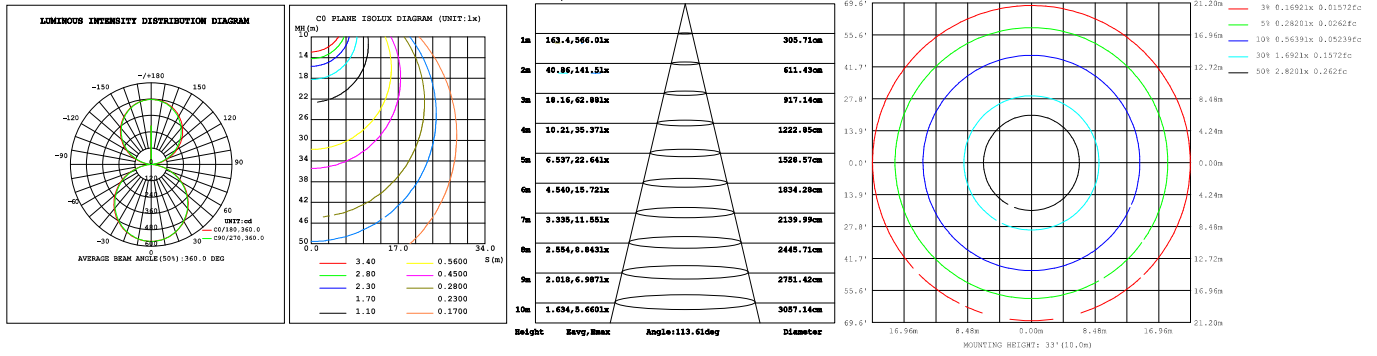

WSD-OL4FT404550W27-3545K (50W&4000K)

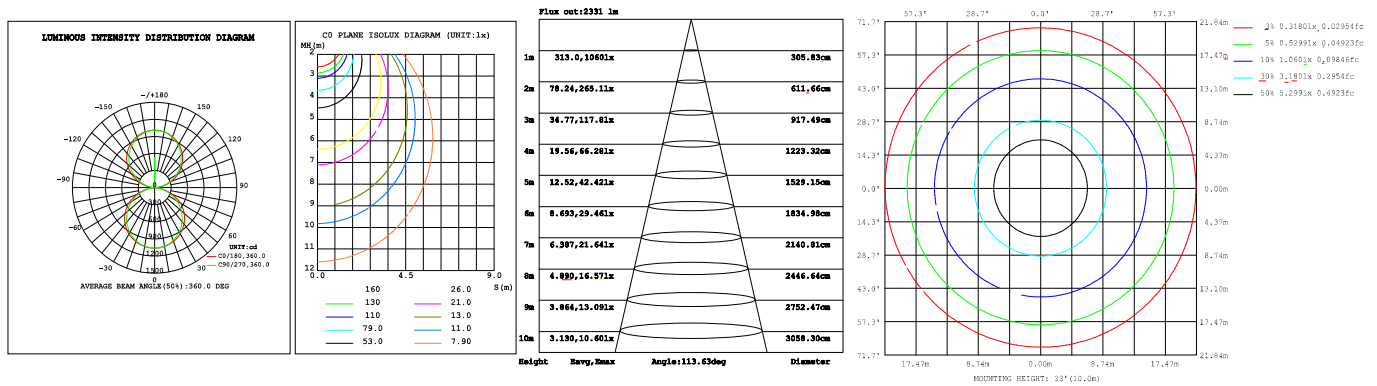

WSD-OL8FT657590W27-3545K (90W&4000K)

