

STRAIGHT SQUARE ALUMINUM POLES - WSD Series

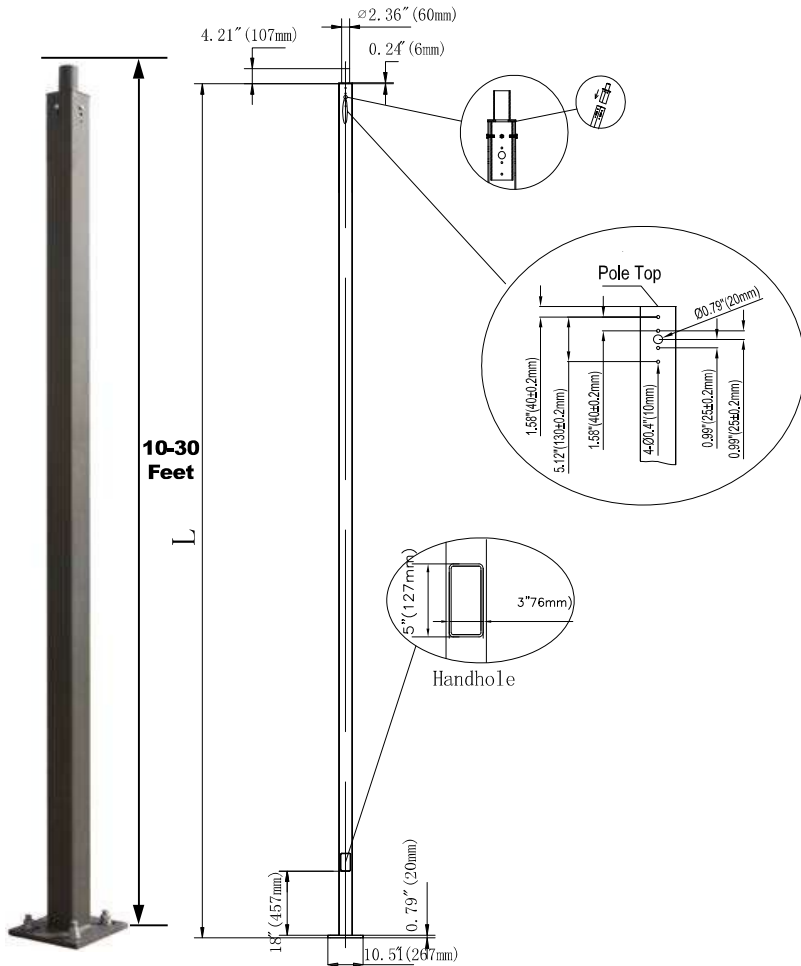

The WSD LED INC Series Square aluminum poles are built from high strength aluminum Square tube and are available side drilled for arm mounted area lighting luminaires or with tenon mounts for flood and post top luminaires. Typical area lighting applications include retail centers, industrial parks, schools and universities, public transit and airports, office buildings and medical facilities. Mounting heights of 10 to 30 feet can be used based on selected luminaire application.

Specifications and Features: Pole

(Accessories need to purchased separately)

Specifications:

The pole shaft is extruded from seamless 6061-T6 aluminum. Conforms to ASTM F1554 Grade 55.

Finish:

Textured Architectural Bronze Powdercoat Finish, Baked to Ensure Maximum Paint Adhesion, Hardness and Durability.

Anchor Bolts:

Anchor Bolts are not Included, Sized Based on Pole Data Charts for the Selected Pole Size.

Base Cover:

Poles are Provided With a Two-Piece Formed aluminum Base Cover that is Easily Assembled and Fitted Over Pole Base.

Pole Length:

Poles are Available in Standard Lengths as Shown in the Order Matrix. Poles can be Custom Cut to Order. Consult Factory.

Mounting Options:

Standard Length Poles Include 2 3/4" OD Tenon, Side Drilled 4@90 Degrees, Polycarbonate Top Cover and Hole Plugs for Unused Drilling Locations.

Cut To Order Poles can be Side Drilled for 2@180 Degrees or 4@90 Degrees, Includes Polycarbonate Top Cover and Hole Plugs for Unused Drilling Locations.

Cut To Order Poles May Also Be Ordered With 2 3/4" OD Tenons for Use With Post Top Decorative Luminaires, Flood/Area Slip Fitter Fixtures, or Any of a Wide Variety of Pole Top Mounting Accessories.

Our standard equipment is to make a top adapter with 2.5 inches. There is no opening on the top of the light pole. If ARM installation is needed, the top adapter shall be removed and holes shall be opened on the wall of the light pole. Finally, seal the top with a plastic rain cover.

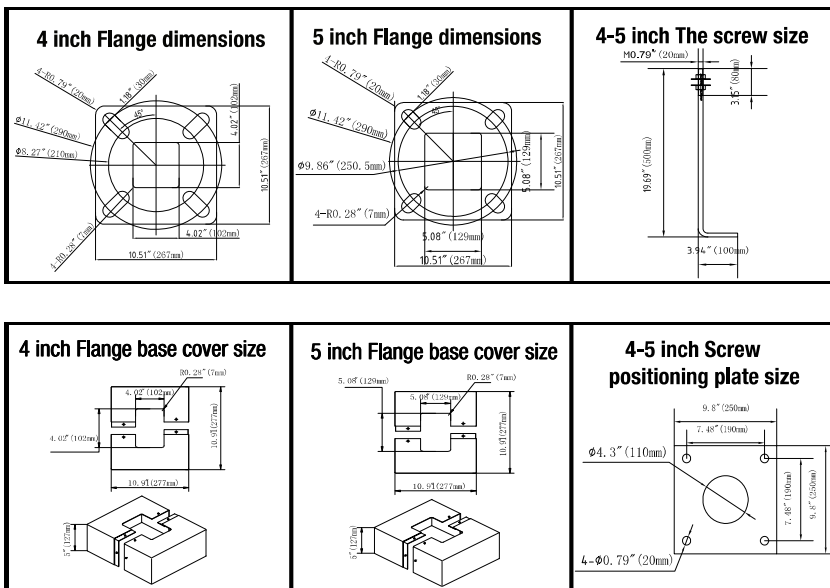

STRAIGHT SQUARE ALUMINUM POLES - WSD Series

Specifications:

Specification type	10FT	15FT	20FT	25FT	30FT
WSD-SAL10FT4-125-D-T	L=3.0 (m)	L=4.6 (m)	L=6.1 (m)	L=7.6 (m)	L=9.1 (m)
WSD-SAL15FT4-125-D-T					
WSD-SAL20FT4-125-D-T					
WSD-SAL25FT4-255-D-T					
WSD-SAL30FT5-255-D-T					

Dimension data:

Catalog #	Mt. height	Wall thickness	Shaft size	Bolt size	Pole weight	EPA 80	EPA 90	EPA 100	EPA 110	EPA 120
WSD-SAL10FT4-125-D-T	10 ft.	0.125 in.	4x4 in.	M0.79"X19.69"X3.94"	41 lbs.	13.5	11.3	8.9	7.3	6.8
WSD-SAL15FT4-125-D-T	15 ft.	0.125 in.	4x4 in.		55 lbs.	7.3	5.1	4.4	3.8	2.9
WSD-SAL20FT4-125-D-T	20 ft.	0.125 in.	4x4 in.		88 lbs.	3.2	2.6	1.5	0.9	0.3
WSD-SAL25FT4-255-D-T	25 ft.	0.255 in.	4x4 in.		132 lbs.	8.3	6.2	5.2	4.2	3.6
WSD-SAL30FT5-255-D-T	30 ft.	0.255 in.	5x5 in.	M0.79"X36"X4"	198 lbs.	10.1	7.0	5.7	3.7	2.4

National Wind Velocity Map

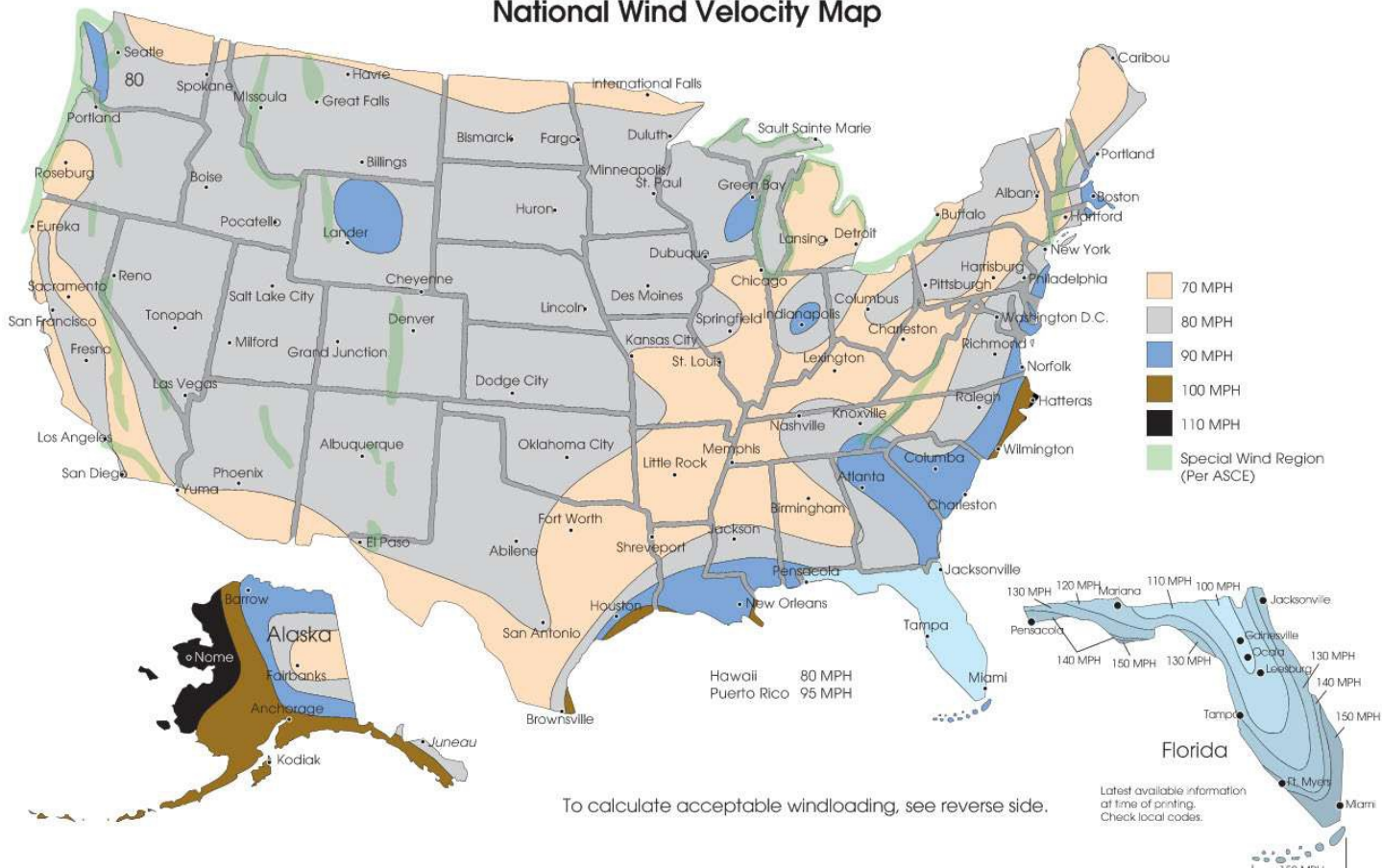



SQUARE EXTERNAL MOUNT HORIZONTAL TENON · To mount 2/3/4 fixtures on an existing pole

 <p>Dimensions: 45" (1143mm) total length, 15.82.36" (403mm) between tenons, 20.5" (520mm) between tenons, 4.72" (120mm) tenon length, 1.31" (33mm) tenon diameter, 6.48" (165mm) tenon diameter, 1.24" (31.5mm) tenon diameter, 2.5" (64mm) tenon diameter.</p>	<p>Low Profile Bullhorn with 3 Tenons NO. WSD-VTS4R-3T-D MAX EPA: 1.6 Finish: Dark Bronze USE: The Bracket is designed to mount over 2-3/8" O.D. vertical tenon. Two fixtures can be mounted to the Round External Mount Horizontal Tenon and adjusted horizontally.</p>	 <p>Dimensions: 20.5" (520mm) total length, 2.4" (60mm) tenon diameter, 4.7" (120mm) tenon length, 2.53" (64mm) tenon diameter, 24.6" (624.38mm) total length.</p>	<p>Low Profile Bullhorn with 2 Tenons NO. WSD-VTS4R-2T-D MAX EPA: 1.0 Finish: Dark Bronze USE: The Bracket is designed to mount over 2-3/8" O.D. vertical tenon. Two fixtures can be mounted to the Round External Mount Horizontal Tenon and adjusted horizontally.</p>
 <p>Dimensions: 11.62" (295.23mm) total length, 3.82.36" (97mm) tenon diameter, 9.56" (243.84mm) tenon diameter, 3.20" (81.28mm) tenon diameter, 2.44" (62mm) tenon diameter, 3.57" (90.76mm) tenon diameter, 1.18" (30mm) tenon diameter, 8.0" (203.2mm) tenon diameter.</p>	<p>Triple 120° Horizontal Tenon Adaptor NO. WSD-QT120-3T-D MAX EPA: 1.4 Finish: Dark Bronze USE: The Bracket is designed to mount over 2-3/8" O.D. vertical tenon. Two fixtures can be mounted to the Round External Mount Horizontal Tenon and adjusted horizontally.</p>	 <p>Dimensions: 24.4" (619.76mm) total length, 2.0" (50.8mm) tenon diameter, 2.0" (50.8mm) tenon diameter, 2.0" (50.8mm) tenon diameter, 2.0" (50.8mm) tenon diameter, 2.0" (50.8mm) tenon diameter, 2.0" (50.8mm) tenon diameter.</p>	<p>Quad 90° Horizontal Tenon Adaptor NO. WSD-QT90-4T-D MAX EPA: 1.8 Finish: Dark Bronze USE: The Bracket is designed to mount over 2-3/8" O.D. vertical tenon. Two fixtures can be mounted to the Round External Mount Horizontal Tenon and adjusted horizontally.</p>
 <p>Dimensions: 34.4" (875.04mm) total length, 2.0" (50.8mm) tenon diameter, 2.0" (50.8mm) tenon diameter, 2.0" (50.8mm) tenon diameter, 2.0" (50.8mm) tenon diameter, 2.0" (50.8mm) tenon diameter, 2.0" (50.8mm) tenon diameter.</p>	<p>Square Triple 90° Horizontal Tenon Adaptor WSD-QT90-3T-D MAX EPA: 1.5 Finish: Dark Bronze The Bracket is designed to mount over 2-3/8" O.D. vertical tenon.</p>	 <p>Dimensions: 21.4" (544.16mm) total length, 2.0" (50.8mm) tenon diameter, 2.0" (50.8mm) tenon diameter, 2.0" (50.8mm) tenon diameter, 2.0" (50.8mm) tenon diameter, 2.0" (50.8mm) tenon diameter, 2.0" (50.8mm) tenon diameter.</p>	<p>Round Triple 90° Horizontal Tenon Adaptor WSD-SB2.5QD90-3T-D MAX EPA: 0.3 Finish: Dark Bronze The Bracket is designed to mount over 2-3/8" (60mm) O.D. vertical tenon. Triple fixtures can be mounted to the Round External Mount Horizontal Tenon and adjusted horizontally.</p>
 <p>Dimensions: 20.5" (520mm) total length, 15.82.36" (403mm) between tenons, 20.5" (520mm) between tenons, 4.72" (120mm) tenon length, 1.31" (33mm) tenon diameter, 6.48" (165mm) tenon diameter, 1.24" (31.5mm) tenon diameter, 2.5" (64mm) tenon diameter.</p>	<p>Low Profile Bullhorn with 4 Tenons WSD-VTS4R-4T-D MAX EPA: 1.7 Finish: Dark Bronze The Bracket is designed to mount over 2-3/8" O.D. vertical tenon.</p>	 <p>Dimensions: 21.8" (554.72mm) total length, 2.0" (50.8mm) tenon diameter, 2.0" (50.8mm) tenon diameter, 2.0" (50.8mm) tenon diameter, 2.0" (50.8mm) tenon diameter, 2.0" (50.8mm) tenon diameter, 2.0" (50.8mm) tenon diameter.</p>	<p>Four 180° Horizontal Tenon Adaptor WSD-RB2.5TR180-4T-D MAX EPA: 1.4 Finish: Dark Bronze The Bracket is designed to mount over 2-3/8" (60mm) O.D. vertical tenon. Four fixtures can be mounted to the Round External Mount Horizontal Tenon and adjusted horizontally.</p>

WALL BRACKET

- Attaches to any flat surface
- Provides wiring access

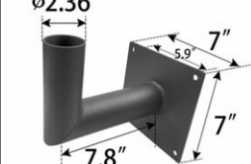
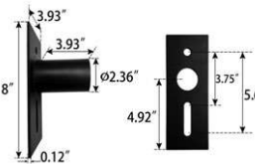
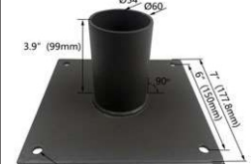
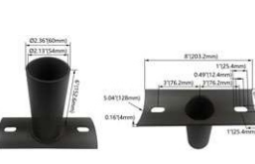
MID-POLE TENON BRACKET

 <p>Dimensions: 7.8" (198mm) total length, 7.8" (198mm) total length, 7.8" (198mm) total length, 7.8" (198mm) total length, 7.8" (198mm) total length, 7.8" (198mm) total length.</p>	<p>90° Wall Mount Bracket with 2-3/8" O.D. Tenon NO. WSD-ADP2.5-90-D Finish: Dark Bronze MAX EPA: 0.6 USE: The 90° wall mount bracket with 2-3/8" tenon attaches flood and area fixtures to almost any surface: wall, roof, or wood pole. Provides wiring access and a built-in 2-3/8" O.D. tenon to mount a fixture with our adjustable slip-fitter. Suggested 3/8" diameter bolts for mounting. Mounting holes are spaced 3-1/4" apart.</p>	 <p>Dimensions: 3.93" (99.8mm) total length, 3.93" (99.8mm) total length, 3.93" (99.8mm) total length, 3.93" (99.8mm) total length, 3.93" (99.8mm) total length, 3.93" (99.8mm) total length.</p>	<p>2-3/8" OD Horizontal Tenon Mid-Pole Bracket NO. WSD-ADP2.5-D Finish: Dark Bronze MAX EPA: 0.3 USE: 2-3/8" OD Horizontal Tenon Mid-Pole Bracket is designed to mount light fixture that is equipped with an adjustable slip-fitter onto a 2-3/8" OD horizontal tenon.</p>
 <p>Dimensions: 3.9" (99mm) total length, 3.9" (99mm) total length, 3.9" (99mm) total length, 3.9" (99mm) total length, 3.9" (99mm) total length, 3.9" (99mm) total length.</p>	<p>180° Wall Mount Bracket with 2-3/8" O.D. Tenon NO. WSD-ADP2.5-180L3.9-D Finish: Dark Bronze MAX EPA: 0.5 USE: The 180° wall mount bracket with 2-3/8" tenon attaches flood and area fixtures to almost any surface: wall, roof, or wood pole. Provides wiring access and a built-in 2-3/8" O.D. tenon to mount a fixture with our adjustable slip-fitter. Suggested 3/8" diameter bolts for mounting. Mounting holes are spaced 3-1/4" apart.</p>	 <p>Dimensions: 4.02" (102mm) total length, 4.02" (102mm) total length, 4.02" (102mm) total length, 4.02" (102mm) total length, 4.02" (102mm) total length, 4.02" (102mm) total length.</p>	<p>2-3/8" OD Horizontal Tenon Arc Adaptor NO. WSD-ADP2.5-BAR5-D Finish: Dark Bronze MAX EPA: 0.3 USE: For use with Round, non-tapered steel and aluminum poles. 2-3/8" OD Horizontal Tenon Mid-Pole Bracket is designed to mount light fixture that is equipped with an adjustable slip-fitter onto a 2-3/8" OD horizontal tenon.</p>
 <p>Dimensions: 8" (203.2mm) total length, 8" (203.2mm) total length, 8" (203.2mm) total length, 8" (203.2mm) total length, 8" (203.2mm) total length, 8" (203.2mm) total length.</p>	<p>5" Round Pole Mount with 3" O.D. Tenon NO. WSD-VTR5-D Finish: Dark Bronze MAX EPA: 0.3 USE: For use with Round, non-tapered steel and aluminum poles. Furnished with two 3/8" hex head stainless-steel bolts. Vertical tenon measures 3" O.D., and is made of steel tubing. Insert round pole adaptor 5inch to 3inch tenon.</p>		

STRAIGHT SQUARE ALUMINUM POLES - WSD Series

POLE BRACKET • For mounting one fixture on an existing pole

	<p>4" Square Pole Mount with 2-3/8" O.D. Tenon NO. WSD-VT54-D Finish: Dark Bronze MAX EPA: 0.3 USE: For use with square, non-tapered steel and aluminum poles. Furnished with four 5/16" hex head stainless-steel bolts. Vertical tenon measures 2-3/8" O.D., and is made of steel tubing. Fixtures mounted to this bracket can be adjusted both vertically and horizontally.</p>		<p>3" Round Pole Mount with 2-3/8" O.D. Tenon NO. WSD-VT3-D Finish: Dark Bronze MAX EPA: 0.3 USE: For use with Round, non-tapered steel and aluminum poles. Furnished with four 3/8" hex head stainless-steel bolts. Vertical tenon measures 2-3/8" O.D., and is made of steel tubing. Fixtures mounted to this bracket can be adjusted both vertically and horizontally.</p>
	<p>5" Square Pole Mount with 2-3/8" O.D. Tenon NO. WSD-VT55-D Finish: Dark Bronze MAX EPA: 0.3 USE: For use with square, non-tapered steel and aluminum poles. Furnished with four 3/8" hex head stainless-steel bolts. Vertical tenon measures 2-3/8" O.D., and is made of steel tubing. Fixtures mounted to this bracket can be adjusted both vertically and horizontally.</p>		<p>4" Round Pole Mount with 2-3/8" O.D. Tenon NO. WSD-VT4-D Finish: Dark Bronze MAX EPA: 0.3 USE: For use with Round, non-tapered steel and aluminum poles. Furnished with four 3/8" hex head stainless-steel bolts. Vertical tenon measures 2-3/8" O.D., and is made of steel tubing. Fixtures mounted to this bracket can be adjusted both vertically and horizontally.</p>
	<p>5" Round Pole Mount with 2-3/8" O.D. Tenon NO. WSD-VT5-D Finish: Dark Bronze MAX EPA: 0.3 USE: For use with Round, non-tapered steel and aluminum poles. Furnished with four 3/8" hex head stainless-steel bolts. Vertical tenon measures 2-3/8" O.D., and is made of steel tubing. Fixtures mounted to this bracket can be adjusted both vertically and horizontally.</p>		<p>NO. WSD-SFARM2-D Finish: Dark Bronze SFARM2 Mount An optional cast aluminum mast arm adapter secures fixture head to nominal 2"(2-3/8"O.D. pipe size) horizontal steel tenon arm.</p>
	<p>NO. WSD-NEWSBARM2-D Finish: Dark Bronze Arm Mount 4" and 5" Square and Round poles. Standard versatile mounting arm is simple to install and can be used with existing poles for retro installations.</p>		<p>NO. WSD-NEWSBSF2-D Finish: Dark Bronze Slipfitter Mount An optional cast aluminum mast arm adapter secures fixture head to nominal 2"(2-3/8"O.D. pipe size) horizontal steel tenon arm.</p>
	<p>NO. WSD-SBT-D Finish: Dark Bronze Easy to install for direct wall mounting with 1/2" conduit wiring.</p>		<p>Base Mounting Screw NO. WSD-BMS-S Before installing the lamp pole, the installation hook should be buried underground and fixed by cement. After fixing, the lamp pole should be fixed by locking screw and base installed.</p>
	<p>Install Base Shield NO. WSD-IBS4-D Finish: Dark Bronze The 4" Installation of base shield is used to protect the base after fixing the lamp pole, so that the lamp pole base is not damaged, thereby increasing the service life of the lamp pole.</p>		<p>Screw Positioning Plate NO. WSD-SPP-D This is a screw rod positioning plate. After the screw rod of the lamp rod base is fixed underground, the positioning plate is fixed with the screw rod to prevent the screw rod from deviation. Finally, the lamp rod is locked.</p>
	<p>Install Base Shield NO. WSD-IBS5-D Finish: Dark Bronze The 5" Installation of base shield is used to protect the base after fixing the lamp pole, so that the lamp pole base is not damaged, thereby increasing the service life of the lamp pole.</p>		<p>Arm Square tube turn tube Tenon Adaptor NO. WSD-ARM-BAR-D Finish: Dark Bronze USE: square tube light bar installation, with Arm installation of lamps.</p>
	<p>Arm Square tube turn tube Tenon Adaptor NO. WSD-SADP-BAR-D Finish: Dark Bronze USE: square tube light bar installation, with Arm installation of lamps.</p>		

ORDERING EXAMPLE: WSD-SAL10FT4-125-D-T

WSD	SAL	10FT	4	125	D	T
Company	Product	Height	Size	Wall Thickness	Finish	Mounting
WSDLED INC	Square aluminum pole	10FT (3.0M)	4 (4X4in.) 5 (5X5in.) 6 (6X6in.)	125 (0.125inch) 255 (0.255inch)	D Dark Bronze	2.5 inch adapter
		15FT (4.6M)				
		20FT (6.1M)				
		25FT (7.6M)				
		30FT (9.1M)				

Fixture Configurations:

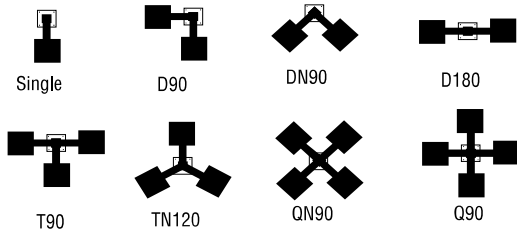

Light pole top:

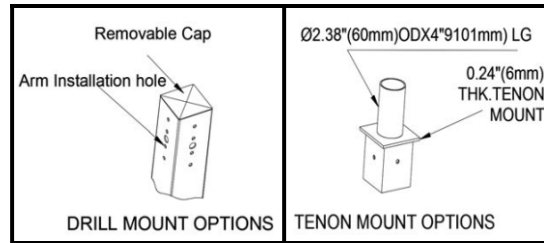

Installation:

1. Dig a hole in the installation position of the lamp pole. Fixed four fastener fittings according to the hole position of lamp pole and poured with cement concrete. (as shown in the figure)

2. Install 4 screws onto the stick and adjust to same water level, then place the square plate and screw tightly. Install the cover at the bottom of pole. (as shown in the figure)

Foundation reference specification

Reference design of Concrete size

Specifications	L	W	H
10-15FT	31.5"(800mm)	31.5"(800mm)	59.1"(1500mm)
20-25FT	35.4"(900mm)	35.4"(900mm)	70.9"(1800mm)
30FT	35.4"(900mm)	35.4"(900mm)	82.7"(2100mm)

ANCHORAGE GUIDE

Foundation Design: We offer Foundation design references due to variations in soil structure across different areas, and we do not assume any responsibility for this variability.