

LED 5CCT SELECTABLE ARCHITECTURAL LINEAR LIGHT - WSD Series

Tunable Wattages:(2FT)10W/12W/16W/20W ; (4FT)20W/24W/32W/40W ; (8FT)40W/48W/64W/80W



WATT/CCT
FIELD-ADJUSTABLE

The Architecture 5CCT Selectable LED Linear Light Series can be widely used for indoor (damp locations) Excellent for hospitals, schools, office, shops, restaurants, storage rooms, supermarkets, etc.

Lighting controls meet design lights consortium (DLC) networked lighting control system technical requirements, LLLC, Energy Monitoring and High End Trim function.



TOP FEATURES

- Field-adjustable Power and CCT.
- Direct-Indirect flux ratio adjustable.
- Continuous run available.
- Multiple connection method.
- 12Vdc auxiliary
- Motion Sensor Control Available (Option)

Dimensions

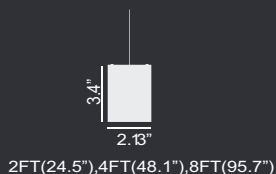

Distributions

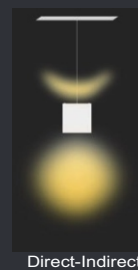

Direct Indirect flux ratio adjustable

Direct	Indirect
100%	0%
70%	30%
50%	50%

SPECIFICATION

	WSD-OL2FT10121620W27-5CCT-W-G2	WSD-OL4FT20243240W27-5CCT-W-G2	WSD-OL8FT40486480W27-5CCT-W-G2
TYPE	WSD-OL2FT10121620W27-5CCT-W-G2	WSD-OL4FT20243240W27-5CCT-W-G2	WSD-OL8FT40486480W27-5CCT-W-G2
WATTAGE	(2FT) 10W/12W/16W/20W	(4FT) 20W/24W/32W/40W	(8FT) 40W/48W/64W/80W
LUMEN	1100 lm/1400lm/1800lm/2300lm	2200 lm/2800lm/3600lm/4600lm	4400 lm/5600 lm/7200 lm/9200lm
EFFICACY	115 lm/W		
CCT	2700K/3000K/3500K/4000K/5000K		
DEFAULT SETTING	Maximum Power & 4000K, Down light 100%, Up light off		
CRI	80		
INPUT VOLTAGE	AC120-277V		
LIGHT ANGLE (One-sided)	110°		
POWER FACTOR	0.90		
DRIVER EFFICACY	86%		
DIMMING	0-10V Dimming (12Vdc auxiliary dimming)		
WORKING TEMPERATURE	-4°F ~ 122°F		
LIFESPAN (L70)	> 100,000 hours		
PROTECTION LEVEL	Damp locations		
CABLE	5core, 18AWG 47.83 inch (SOLD SEPARATELY)		
WARRANTY	5 year limited		

LED 5CCT SELECTABLE ARCHITECTURAL LINEAR LIGHT - WSD Series

Tunable Wattages:(2FT)10W/12W/16W/20W ; (4FT)20W/24W/32W/40W ; (8FT)40W/48W/64W/80W

DIMENSION :

Unit:mm/inch

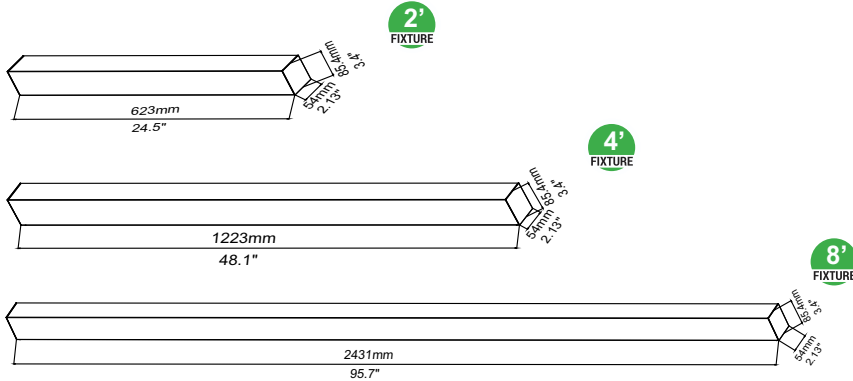

WATTAGE	10W/12W/16W/20W
WEIGHT(G,W)	3.63 lbs (1 pcs/carton)
OUTER BOX	25.78"X7.95"X7.44"(6 pcs/CTN)
INNER BOX	25.15"X2.48"X3.46"(1 pcs/CTN)
WATTAGE	20W/24W/32W/40W
WEIGHT(G,W)	6.60 lbs (1 pcs/carton)
OUTER BOX	49.40"X7.95"X7.44"(6 pcs/CTN)
INNER BOX	48.77"X2.48"X3.46"(1 pcs/CTN)
WATTAGE	40W/48W/64W/80W
WEIGHT(G,W)	13.20 lbs (1 pcs/carton)
OUTER BOX	97.48"X5.35"X8.07"(4 pcs/CTN)
INNER BOX	96.57"X2.48"X3.54"(1 pcs/CTN)

EMERGENCY BACK-UP: (SOLD SEPARATELY)



(Available only for
4FT and 8FT models)

WSD-EMS8W27-XX
8W Emergency Backup Battery
LED Driver

WSD-EMS15W27-XX
15W Emergency Backup Battery
LED Driver

WSD-EMS20W27-XX
20W Emergency Backup
Battery LED Driver

CONTROL: (SOLD SEPARATELY)

Unit:mm

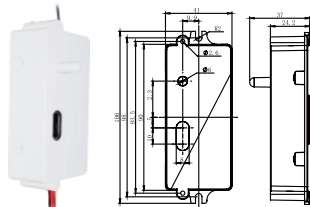

BRI810-B-D
Microwave Motion Sensor



NLC-MW-SQ-005
Microwave Motion Sensor
Note: Build in(Optional)



RC-100
Microwave Sensor Remote Controller
Matching Sensor Model:
NLC-PIR-SQ-001, NLC-MW-SQ-005, BRI810-B-D



Bluetooth
NLC-BT-PIR-SR-001
PIR Bluetooth Microwave Sensor
For Silvair Systems
(Silvair Bluetooth)



NLC-PIR-SQ-001
Bi-Level PIR Infrared Sensor
(DC 12V sensor installation box)



Bluetooth
NLC-BT-PIR-GE-001
PIR Bluetooth
Microwave Sensor For GEBC Systems
(GEBC Bluetooth)



WSD-OL-M-DC
DC Sensor Connection Kit
Matching Sensor Model:
**NLC-PIR-SQ-001, NLC-BT-PIR-SR-001,
NLC-BT-PIR-GE-001**
(2FT,4FT,8FT)

LED 5CCT SELECTABLE ARCHITECTURAL LINEAR LIGHT - WSD Series

Tunable Wattages:(2FT)10W/12W/16W/20W ; (4FT)20W/24W/32W/40W ; (8FT)40W/48W/64W/80W

ACCESSORIES:(SOLD SEPARATELY)

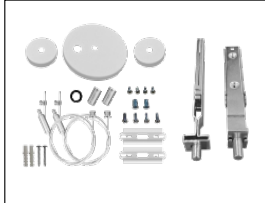

WSD-OL-T-Grid
T-grid Suspension Mount Bracket
Wire Rope Length:Y0.06X39.4 inch (2PCS)
(2FT,4FT,8FT)



WSD-OL-5CPC-W
Five-core Power Cord
Length : 47.83 inch
(2FT,4FT,8FT)

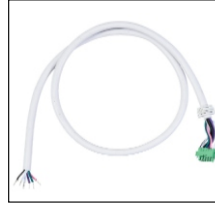

WSD-OL-6CPC-W
Six-core Power Cord
Length: 47.83 inch
Note:Emergency Battery backup
Inputs required
(2FT,4FT,8FT)

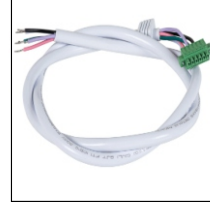

WSD-OL-5CPC-6FT-W
Five-core Power Cord
Length : 6 FT
(2FT,4FT,8FT)

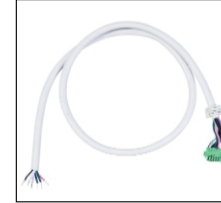

WSD-OL-6CPC-6FT-W
Six-core Power Cord
Length: 6FT
Note:Emergency Battery backup
Inputs required
(2FT,4FT,8FT)



WSD-OL-CANOPY-M
Canopy
Suitable for installation with
Motion Sensor
(2FT,4FT,8FT)

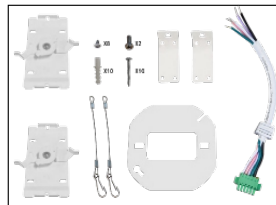

WSD-OL-SMK-WMK-W
Wall and Surface Mounting KIT
Wire Rope Length:Y0.04X4.7 inch (2PCS)
Wire Length : 7.87 inch
(2FT,4FT,8FT)

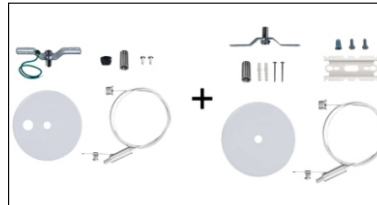

WSD-OL-CIK-A2
Ceiling Install KIT
Wire Rope Length:Y0.06X39.4 inch(2PCS)
(2FT,4FT,8FT)

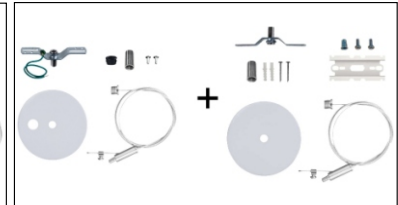

WSD-OL-CIK-6FT-A2
Ceiling Install KIT
Wire Rope Length:Y0.06X6 FT(2PCS)
(2FT,4FT,8FT)

ACCESSORIES:(SOLD SEPARATELY)

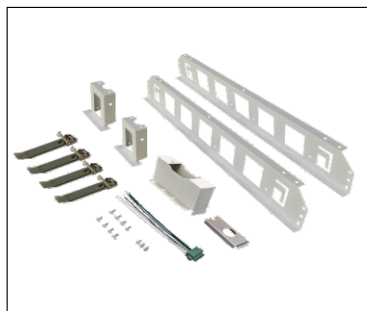

WSD-2FT-OL-RMK-G2
Recessed Mounting Kit
For 2FT Architecture Selectable LED Linear Light

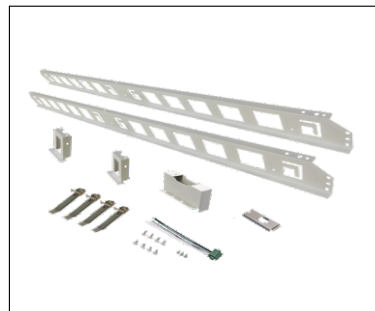

WSD-4FT-OL-RMK-G2
Recessed Mounting Kit
For 4FT Architecture Selectable LED Linear Light

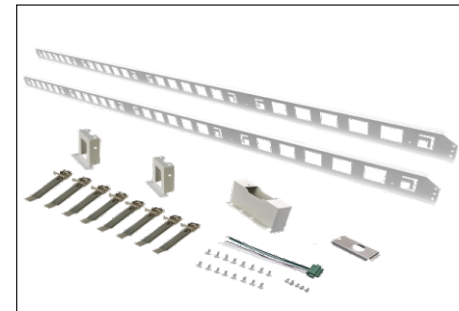

WSD-8FT-OL-RMK-G2
Recessed Mounting Kit
For 8FT Architecture Selectable LED Linear Light

LED 5CCT SELECTABLE ARCHITECTURAL LINEAR LIGHT - WSD Series

Tunable Wattages:(2FT)10W/12W/16W/20W ; (4FT)20W/24W/32W/40W ; (8FT)40W/48W/64W/80W

ORDERING INFORMATION:

EXAMPLE: **WSD-OL2FT10121620W27-5CCT-Z[D,W,B,S]-E[Blank,EC,M,ECM]-G2**

WSD	OL	2FT	10121620W	27	5CCT	Z	E
PRODUCT	PRODUCT	SIZE	WATTAGE	VOLTAGE	CCT	FINISH	CONTROL
WSD (WSD LED INC)	OL (LED Linear Light)	2FT(2-foot)	10121620W - (10W/12W/16W/20W)	27 - (120-277V)	5CCT - (2700K/3000K 3500K/4000K /5000K)	D (Dark Bronze)	M (Motion Sensor)
		4FT(4-foot)	20243240W - (20W/24W/32W/40W)			W (White)	EC (Emergency)
		8FT(8-foot)	40486480W - (40W/48W/64W/80W)			B (Black) S (Silvery)	ECM (Emergency+Motion Sensor)

CONNECTION METHOD:

Fast and seamless connection



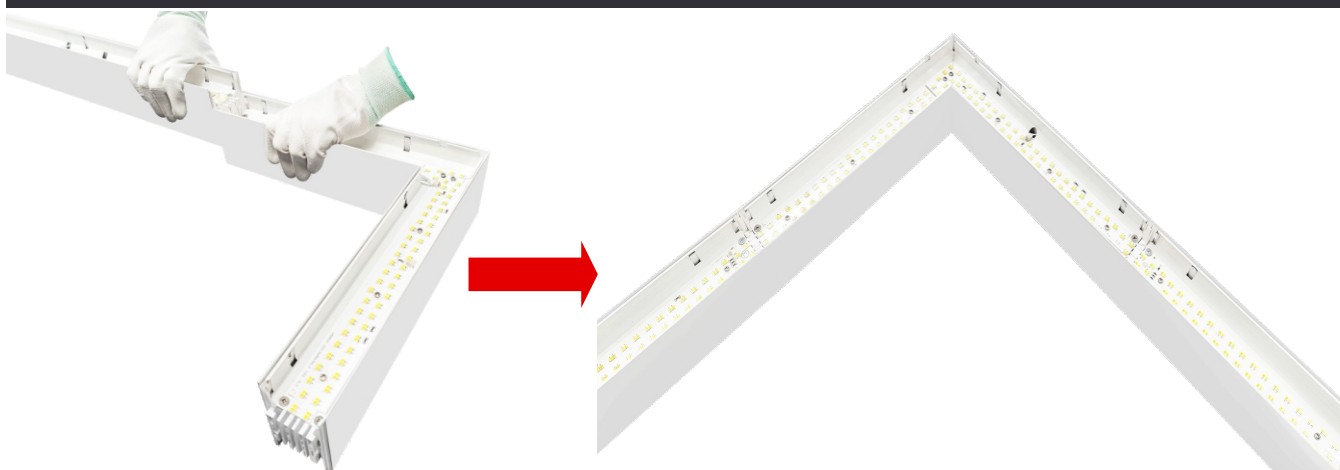
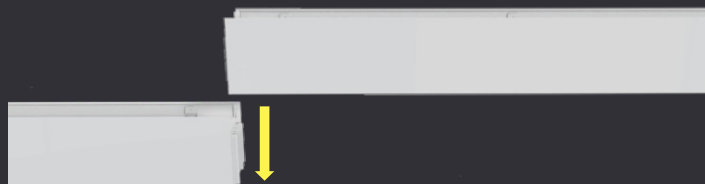

Screw free to remove end cover.
Tool free press lock connection.

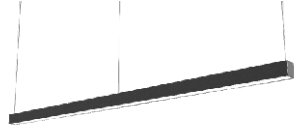

LED 5CCT SELECTABLE ARCHITECTURAL LINEAR LIGHT - WSD Series

Tunable Wattages:(2FT)10W/12W/16W/20W ; (4FT)20W/24W/32W/40W ; (8FT)40W/48W/64W/80W

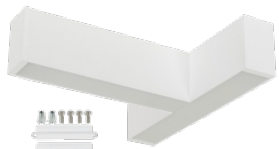
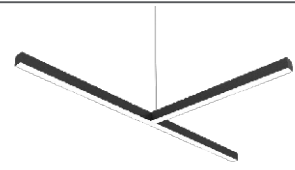
MULTIPLE CONNECTION METHOD: (SOLD SEPARATELY)

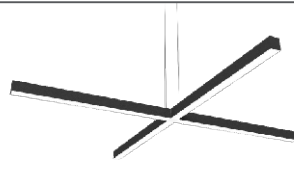
 <p>"I" connecting with Straight shape connector (There is no need to add additional connectors, and the two ends of the lamp do not need to be screwed.)</p>	 <p>WSD-OL90-2T-G2 "L" connector (Field-adjustable Power and CCT)</p>  <p>"L" connecting with 'L' shape connector</p>
 <p>WSD-OL90-3T-G2 "T" connector (Field-adjustable Power and CCT)</p>  <p>"T" connecting with 'T' shape connector</p>	 <p>WSD-OL90-4T-G2 "AAA" connector (Field-adjustable Power and CCT)</p>  <p>"AAA" connecting with 'AAA' shape connector</p>

Warning! Each Power Feed: Total connected load is ≤500W at 120V and ≤1000W at 277V.

PERFORMANCE:

SPECIFICATION															
TYPE	WSD-OL90T-G2														
POWER	110W					112W					116W				
CCT	2700K	3000K	3500K	4000K	5000K	2700K	3000K	3500K	4000K	5000K	2700K	3000K	3500K	4000K	5000K
LUMENS	1089	1105	1130	1148	1183	1342	1363	1392	1415	1457	1884	1736	1762	1800	1830
EFFICACY	>107	>108	>110	>112	>116	>108	>109	>112	>113	>117	>108	>109	>111	>113	>116
TYPE	WSD-OL90T-G2					WSD-OL90T-G2									
POWER	20W					110W					112W				
CCT	2700K	3000K	3500K	4000K	5000K	2700K	3000K	3500K	4000K	5000K	2700K	3000K	3500K	4000K	5000K
LUMENS	2217	2251	2301	2338	2405	1122	1138	1163	1182	1220	1321	1340	1384	1404	1448
EFFICACY	>106	>107	>109	>111	>114	>107	>108	>111	>112	>116	>108	>109	>113	>114	>118
TYPE	WSD-OL90T-G2										WSD-OL90T-G2				
POWER	116W					20W					110W				
CCT	2700K	3000K	3500K	4000K	5000K	2700K	3000K	3500K	4000K	5000K	2700K	3000K	3500K	4000K	5000K
LUMENS	1718	1745	1784	1814	1869	2193	2227	2278	2316	2384	1080	1096	1120	1140	1177
EFFICACY	>109	>110	>112	>114	>118	>107	>108	>110	>112	>116	>104	>105	>108	>109	>113
TYPE	WSD-OL90T-G2														
POWER	112W					116W					20W				
CCT	2700K	3000K	3500K	4000K	5000K	2700K	3000K	3500K	4000K	5000K	2700K	3000K	3500K	4000K	5000K
LUMENS	1273	1292	1322	1344	1387	1647	1673	1717	1741	1795	2104	2137	2186	2223	2290
EFFICACY	>105	>106	>108	>110	>114	>105	>106	>109	>110	>113	>103	>104	>106	>108	>111

Tunable Wattages:(2FT)10W/12W/16W/20W ; (4FT)20W/24W/32W/40W ; (8FT)40W/48W/64W/80W

CONTROL MODULE:



Wattage Selector



Controls Connect Switch

Direct-Indirect Flux Output Ratio Selector



5 CCT Selector

MOUNTING (SOLD SEPARATELY)

Pendent mount, surface mount, wall mount, recessed mount are available with accessories(purchase separately).

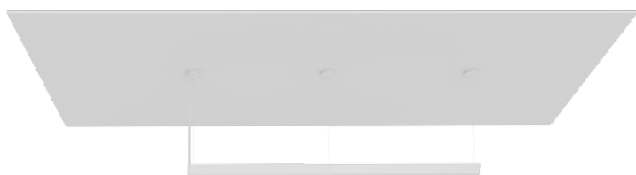

Pendent mount



Surface mount



Recessed mount



Wall mount

LED 5CCT SELECTABLE ARCHITECTURAL LINEAR LIGHT - WSD Series

Tunable Wattages:(2FT)10W/12W/16W/20W ; (4FT)20W/24W/32W/40W ; (8FT)40W/48W/64W/80W

PHOTOMETRICS :

For complete IES files, please visit our website.

WSD-OL2FT10121620W27-5CCT-W-G2 (20W&4000K Down light 50%, Up light 50%)

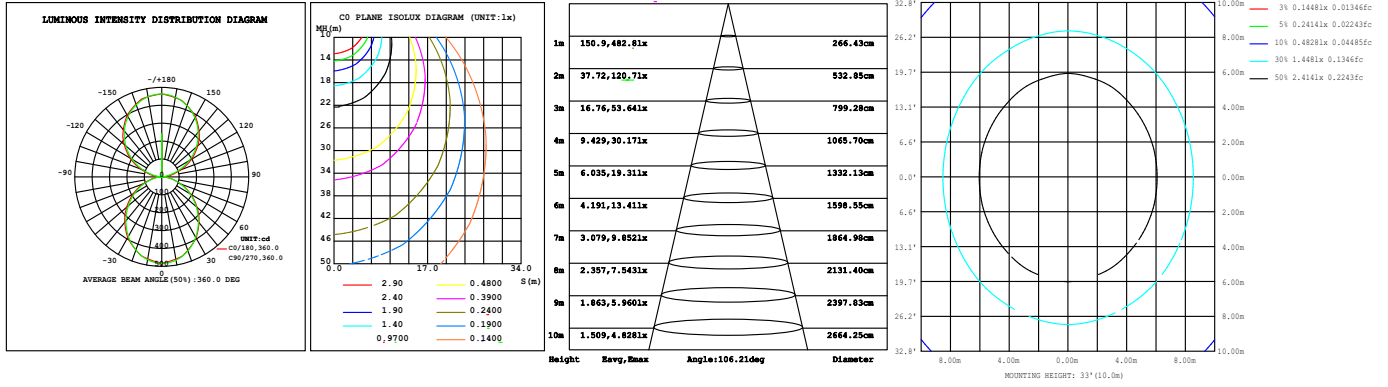

WSD-OL4FT20243240W27-5CCT-W-G2 (40W&4000K Down light 50%, Up light 50%)

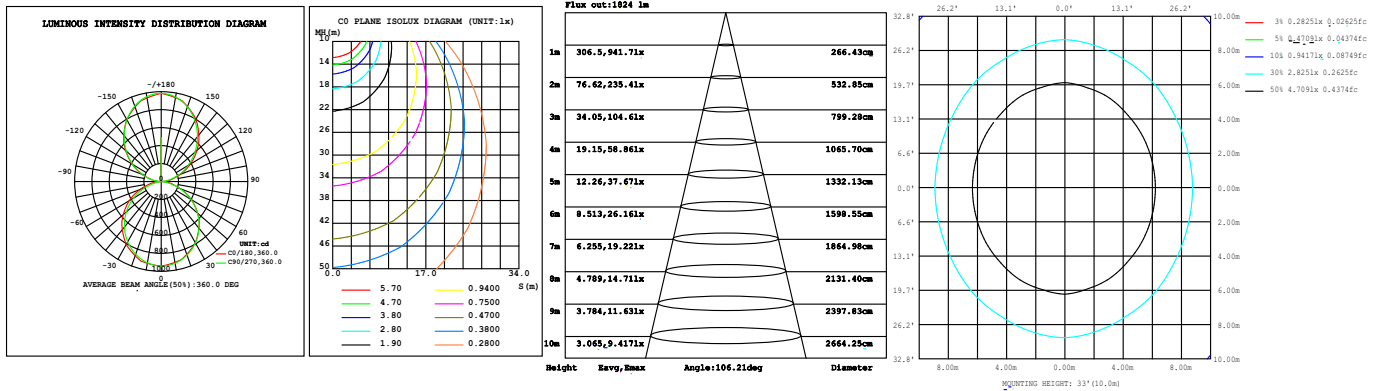

WSD-OL8FT40486480W27-5CCT-W-G2 (80W&4000K Down light 50%, Up light 50%)

